

VARIANCE® P

System pro skleněné obklady



We Build the Invisible

CLASSIC DECOR CONSTRUCT SABCO SWIMSIDE

Member of
**SIMONSWERK
GROUP**

Tél. +33(0) 4 50 08 39 00 | info@sadev.com
76, chemin des Poses - 74330 Poisy (France)

sadev.com

follow us on



© Document issued by Sadev - Reproduction, modification and communication forbidden without authorization. Photo credits © Sadev - DOC-BRO-VARIANCEP-GB-10-2023



We Build the Invisible

Member of
**SIMONSWERK
GROUP**

PATENTED 

Instalace na všechny
typy budov
(nové i
rekonstruované)

VARIANCE® P

VARIANCE® P je patentovaný systém obkladů stěn ze skleněných panelů (a také kompozitních a betonových panelů BEFUP), který umožňuje jednoduché a rychlé obložení stěn.

Jeho hákový systém přináší do procesu instalace jednoduchost, což vede k výrazné úspoře času a financí

Předmontáž v dílně optimalizuje logistiku a manipulaci s obkladovými prvky.

Technologie Single Hook rozšiřuje svou působnost na dvojitě pláště, vnitřní a vnější fasády.

VARIANCE P je kompatibilní s jakoukoli geometrií, symetrickou i asymetrickou, horizontálním i vertikálním uspořádáním a různými typy nosných a rámových konstrukcí, včetně dřevěných ráků.

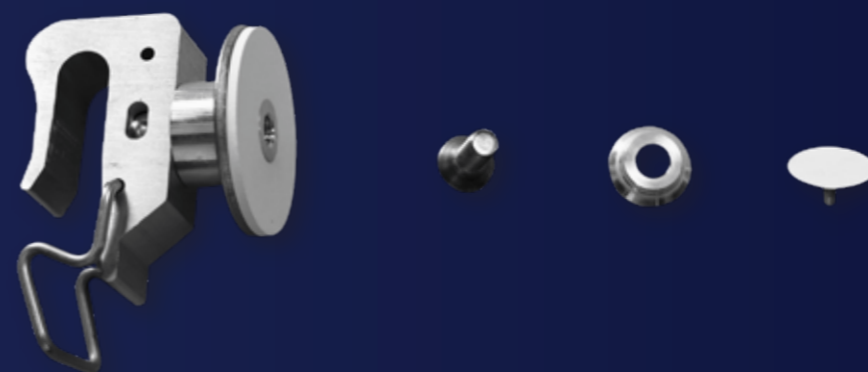

Hlavní výhody obkladového systému Variance P

- 1 zadržování tepla v budově v zimním období a izolace v případě vysokých venkovních teplot.
- 2 výrazně snižuje tepelné mosty a problémy s těsněním.
- 3 delší životnost fasády, protože chrání budovu před nepřízní počasí;
- 4 v případě renovace umožňuje náš systém zachovat čistou podlahovou plochu.
- 5 hákový upevňovací systém nevyžaduje žádné lepení ani schnutí
- 6 snadná údržba v případě výměny obkladu.

SYSTEM

Instalace na kolejnice

Různé povrchy pro instalaci:
hliník, dřevo, beton, kámen



Všechny typy nosníků
Není dodávka SADEV



Horizontální sekundární
struktura
Specifický profil zvaný
„rail“

Zavěšení panelů na kolejnice

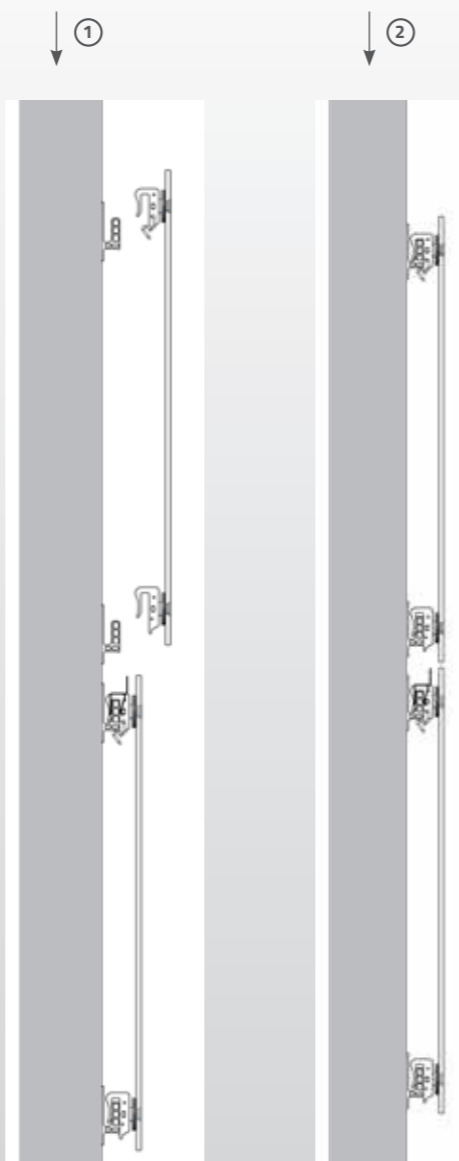

Hákový systém usnadňuje pokládku skla a šetří čas.

Tato technologie rozšiřuje své použití na dvojité pláště a vnitřní i vnější fasádní obklady.

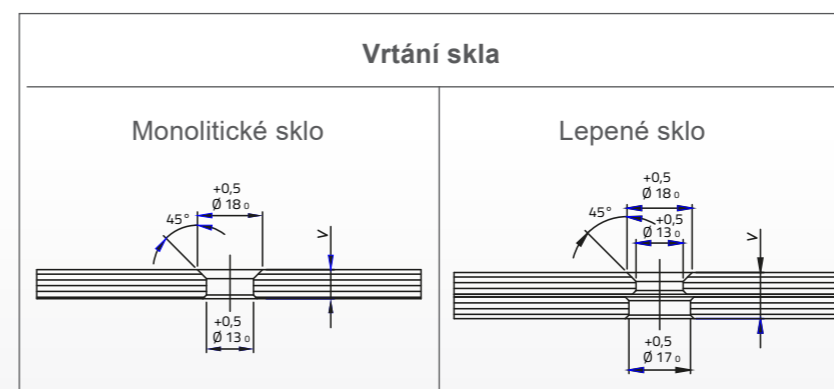

Tloušťku skla určete podle rozměrů a tlaku větru na straně 13.

Instalační výhody

Skryté upevnění ve skle
(montáž na místě nebo ve výrobě)

Zvedá se pouze sklo

Optimalizace času pro
jeřáb

Automatické zavěšení skla



Vložte kroužek, spojte šroubem a utáhněte hák.



Vložte krytku.



Zavěšte háky na kolejnici.



Vložte klip pro horizontální
zajištění panelu.

SYSTEM

System, který zabraňuje namáhání skla !

Hák s ochranou proti zvednutí

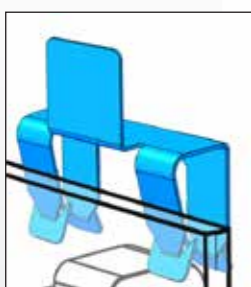
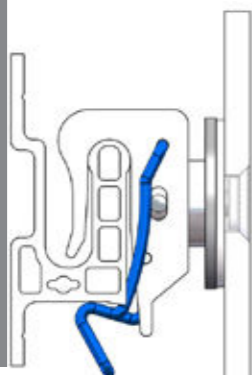

Zařízení proti přemístění (seismická zóna, záporný sklon, extrémní tlak větru...)

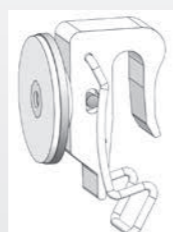
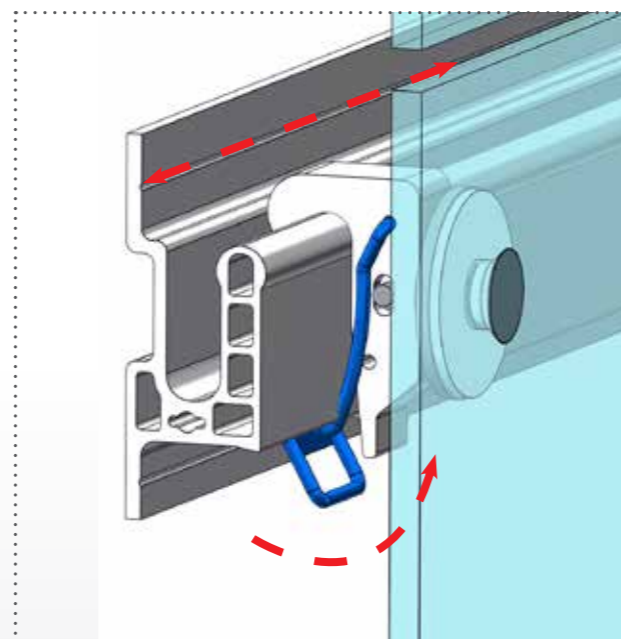

▪ **Zátěžové háky** jsou nosné . Jsou zavěšeny na horní liště a zajišťují také funkci proti zvedání.

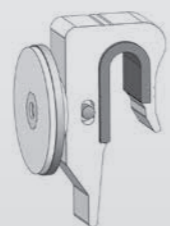

▪ **Závětrné háky** jsou body, které drží panel v tlaku pod vlivem působením větru

Závětrný hák redukuje hluk způsobený větrem



▪ **EXPANZNÍ BOD** Tento háček umožňuje horizontální pohyb.

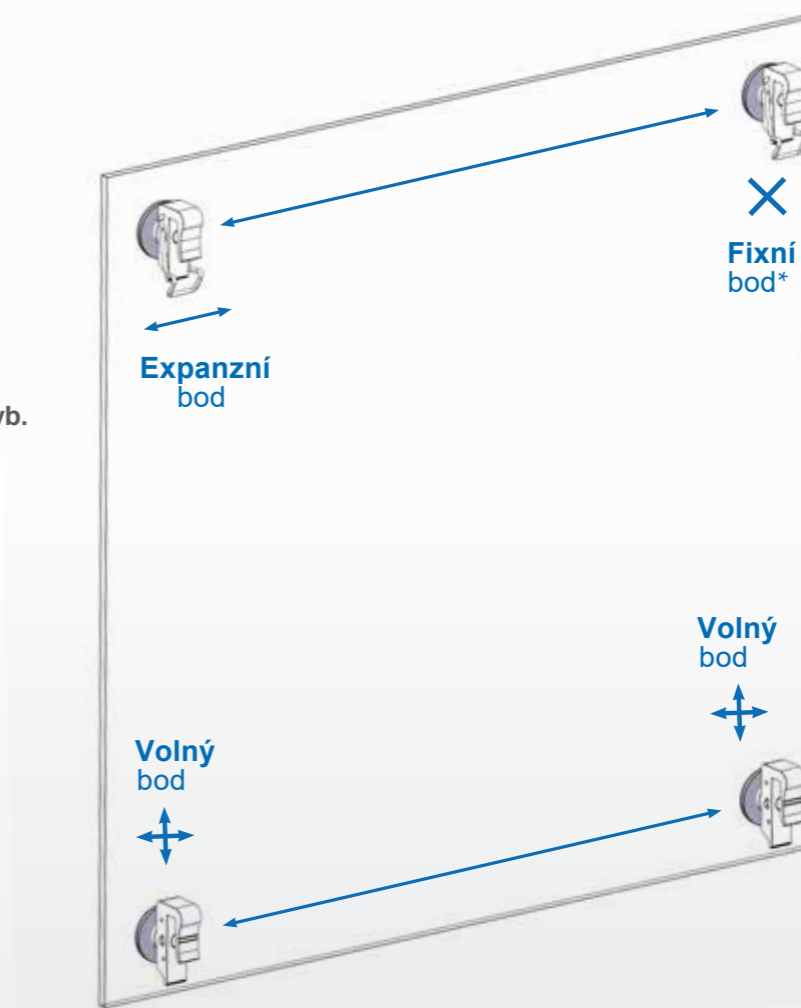

▪ **PEVNÝ BOD** Tento bod je zcela zablokován a brání jakémukoli pohybu. V tomto případě se jedná o pevný referenční bod.

* Pevný bod může být umístěn vpravo nebo vlevo, podle toho jak je instalováno sklo

▪ **BODY VOLNÉ** Háčky jsou delší, aby umožnily snadnou oporu a zaháknutí během háčkování instalaci. Svislá polohovací mezera mezi lištou a hákem umožňuje horizontální i vertikální posun panelu. (roztahení).

Technické výhody

Unikátní adaptérový systém

Minimalistický systém zavěšení.

Rovnoměrné zatížení mezi všemi úchyty.

Odolnost proti nárazům (až úroveň Q4).

Kompatibilní
Monolitické i lepené sklo



Ekologické řešení

Skleněné panely mohou mít na jedné fasádě různé rozměry.

Nezávislé upevnění



Architektonické výhody

HODÍ SE PRO VŠECHNY TVARY A SKLONY STĚN, OD SVISLÝCH AŽ PO PŘEVISY A STROPNÍ PŘÍZDÍVKY.

POUŽITÍ MNOHA OBLOŽENÍ NA STEJNÉM RÁMU

Dejte fasádě objem

možnost instalace skla ve 3D efektech



Ekologický

ANALÝZA ŽIVOTNÍHO CYKLU VÝROBKU
100% RECYKLOVATELNÝ

SYSTEM VYROBENÝ Z RECYKLOVANÝCH PRODUKTŮ.

TEPELNĚ A ZVUKOVĚ IZOLAČNÍ SCHOPNOST
(V ZÁVISLOSTI NA ZVOLENÉ IZOLACI).

IDEÁLNÍ PRO FOTOVOLTAICKÉ FASÁDY (SE SKLONEM NEBO BEZ SKLONU).

PROHLÁŠENÍ O EKOLOGICKÝCH VÝROBCÍCH (EPD).
RT2012/RE2020: IDEÁLNÍ PRO VNĚJŠÍ IZOLACI
PŘI RENOVAČNÍCH PROJEKTECH..

Minimalistické řešení

Náš systém umožní realizaci jakékoliv fasády. Standardní i atypické



Architektonické výhody

INEVIDITELNÉ UPEVNĚNÍ.

MONOLITICKÉ TVRZENÉ SKLO
/VRSTVENÉ TVRZENÉ SKLO

FOTOVOLTAICKÉ SOLÁRNÍ
PANELY.

INSTALACE NA NOVÉ STAVBĚ
NEBO RENOVACI.

Příklady dostupných skel od prtnerů SADEV

Rglass email - VIP 51



Rglass email - VIP 62



SGG Emalit Evolution - Black



SGG Emalit Evolution - Blue Grey



AGC Lacobel T - Petrol green

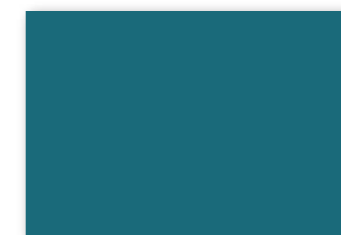

AGC Lacobel T - Zen grey

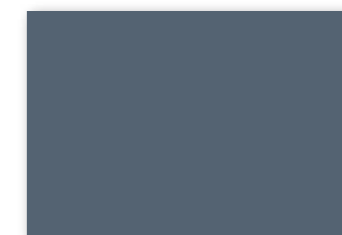

Vlastnosti

jak vybrat tloušťku skla?

Příklad : Monolitické zasklení - 4 úchyty - Výška : 1.4 m - Šířka : 1.8 m
 Tlak na element: 400 Pa > vyberte tloušťku 8 mm .

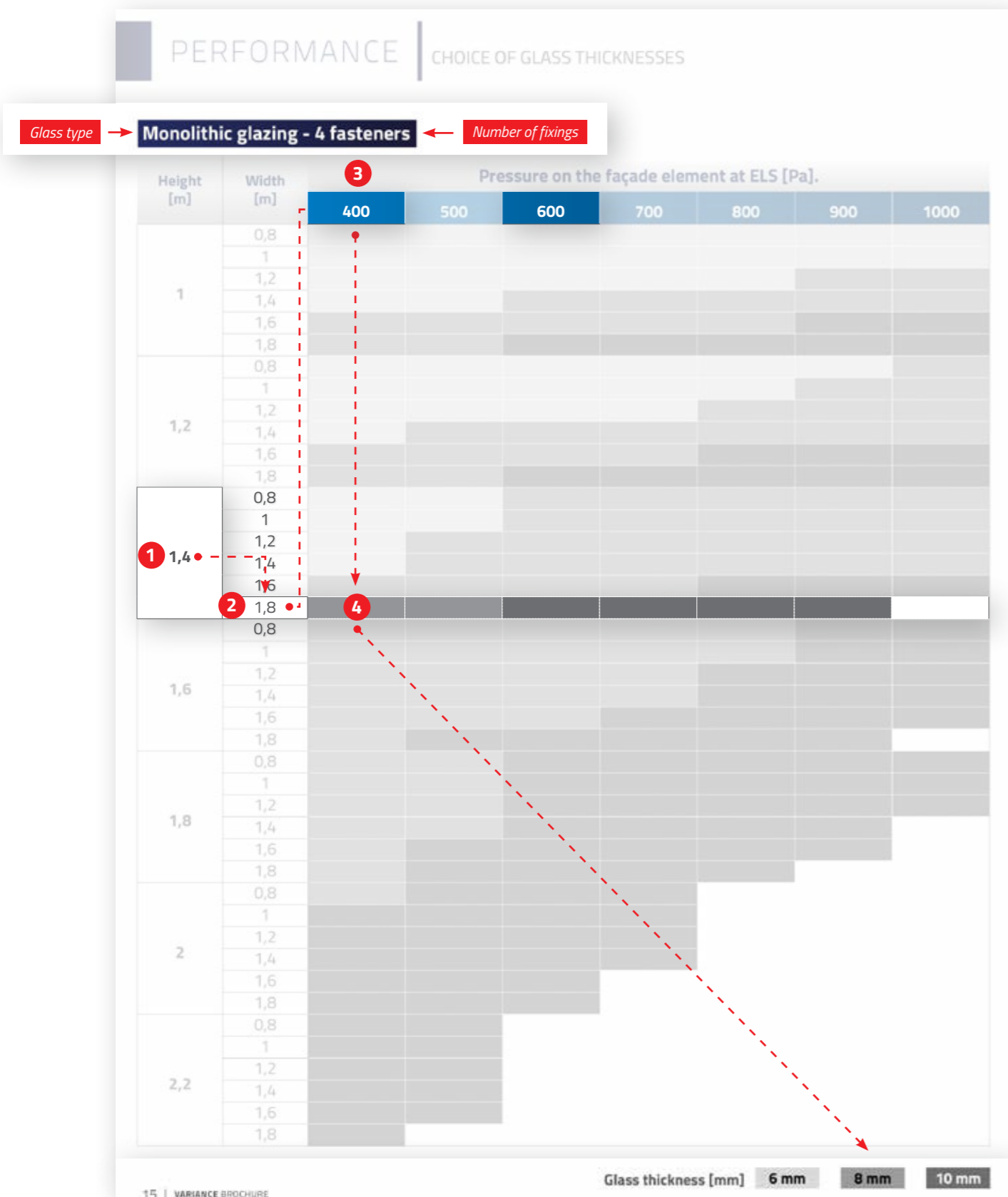

Vlastnosti

Jak najít maximální přípustný tlak vzduchu?

Příklad : Monolitické sklo 4 úchyty - Tloušťka 8 mm : Výška : 1.4 m - Šířka : 1.8
 Maximální přípustný tlak vzduchu > 509 Pa

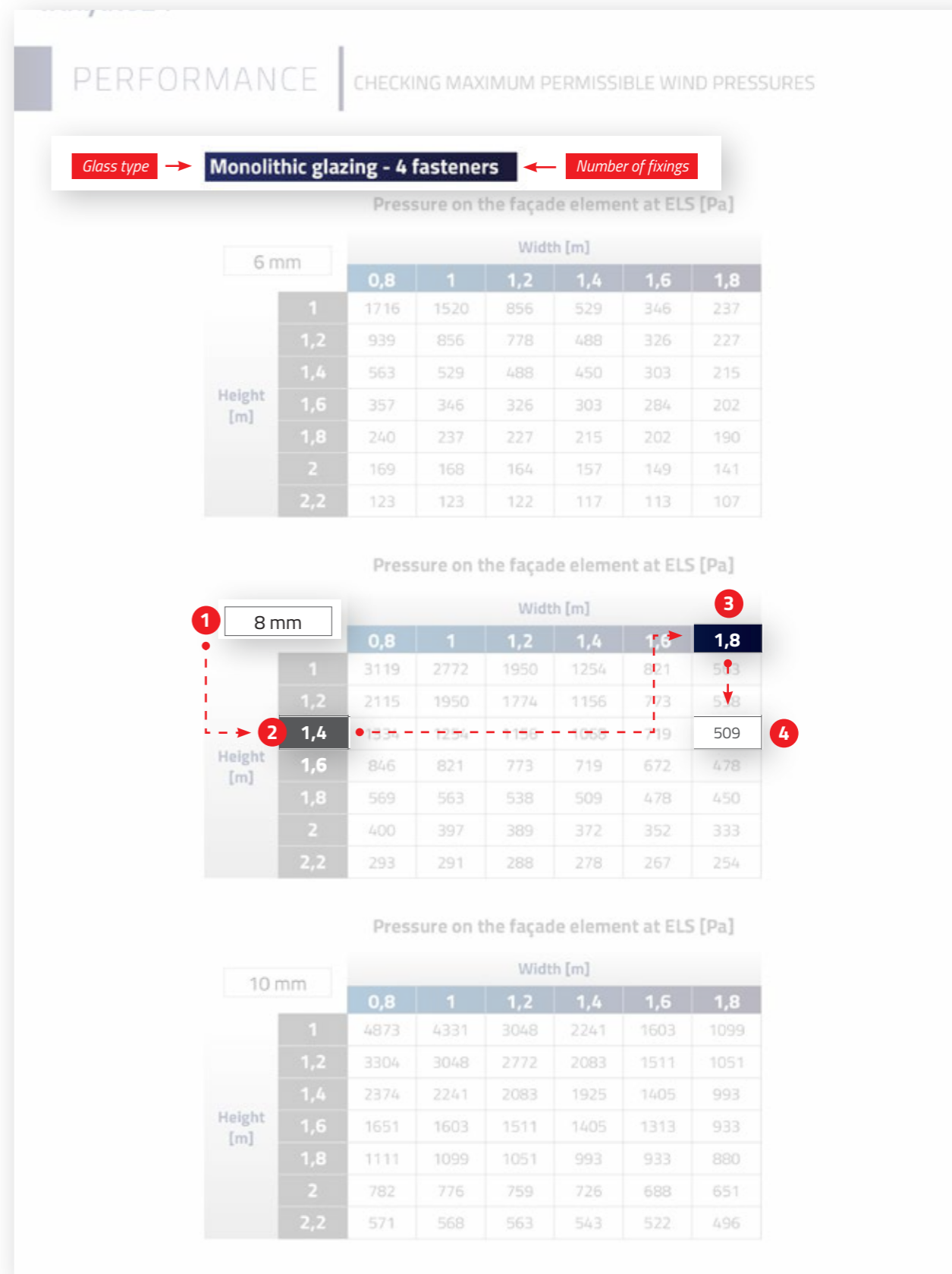

Vlastnosti

Výběr tloušťky skla

Monolitické zasklení - 4 úchyty

Výška [m]	Šířka [m]	Tlak větru na fasádní prvek při SLS (Serviceability Limit State) [Pa]						
		400	500	600	700	800	900	1000
1	0,8							
	1							
	1,2							
	1,4							
	1,6							
	1,8							
1,2	0,8							
	1							
	1,2							
	1,4							
	1,6							
	1,8							
1,4	0,8							
	1							
	1,2							
	1,4							
	1,6							
	1,8							
1,6	0,8							
	1							
	1,2							
	1,4							
	1,6							
	1,8							
1,8	0,8							
	1							
	1,2							
	1,4							
	1,6							
	1,8							
2	0,8							
	1							
	1,2							
	1,4							
	1,6							
	1,8							
2,2	0,8							
	1							
	1,2							
	1,4							
	1,6							
	1,8							

Tloušťka skla [mm] **6 mm** **8 mm** **10 mm**

Vlastnosti

Výběr tloušťky skla

Monolitické zasklení 4 úchyty

Výška [m]	Šířka [m]	Tlak větru na fasádní prvek při SLS (Serviceability Limit State) [Pa]							
		1100	1200	1300	1400	1500	1600	1700	1800
1	0,8								
	1								
	1,2								
	1,4								
	1,6								
	1,8								
1,2	0,8								
	1								
	1,2								
	1,4								
	1,6								
	1,8								
1,4	0,8								
	1								
	1,2								
	1,4								
	1,6								
	1,8								
1,6	0,8								
	1								
	1,2								
	1,4								
	1,6								
	1,8								
1,8	0,8								
	1								
	1,2								
	1,4								
	1,6								
	1,8								
1,8	0,8								

Tloušťka skla [mm] **6 mm** **8 mm** **10 mm**

Tabulky výkonnosti stanovené pro zasklení s upevňovacími prvky umístěnými 100 mm od okraje zasklení. K dispozici jsou rozměry 2,80 x 3,60 m.

Pro ověření vlastností výrobku a zasklení kontaktujte společnost SADEV.

Vlastnosti

Volba tloušťky skla

Monolitické zasklení - 6 úchytů

Výška [m]	Šířka [m]	Tlak větru na fasádní prvek při SLS (Serviceability Limit State) [Pa]									
		400	500	600	700	800	900	1000	1100	1200	1300
1,6	1	6	8	10	12	14	16	18	20	22	24
	1,2	6	8	10	12	14	16	18	20	22	24
	1,4	6	8	10	12	14	16	18	20	22	24
	1,6	6	8	10	12	14	16	18	20	22	24
	1,8	6	8	10	12	14	16	18	20	22	24
1,8	1	6	8	10	12	14	16	18	20	22	24
	1,2	6	8	10	12	14	16	18	20	22	24
	1,4	6	8	10	12	14	16	18	20	22	24
	1,6	6	8	10	12	14	16	18	20	22	24
	1,8	6	8	10	12	14	16	18	20	22	24
2	1	6	8	10	12	14	16	18	20	22	24
	1,2	6	8	10	12	14	16	18	20	22	24
	1,4	6	8	10	12	14	16	18	20	22	24
	1,6	6	8	10	12	14	16	18	20	22	24
	1,8	6	8	10	12	14	16	18	20	22	24
2,2	1	6	8	10	12	14	16	18	20	22	24
	1,2	6	8	10	12	14	16	18	20	22	24
	1,4	6	8	10	12	14	16	18	20	22	24
	1,6	6	8	10	12	14	16	18	20	22	24
	1,8	6	8	10	12	14	16	18	20	22	24
2,4	1	6	8	10	12	14	16	18	20	22	24
	1,2	6	8	10	12	14	16	18	20	22	24
	1,4	6	8	10	12	14	16	18	20	22	24
	1,6	6	8	10	12	14	16	18	20	22	24
	1,8	6	8	10	12	14	16	18	20	22	24
2,6	1	6	8	10	12	14	16	18	20	22	24
	1,2	6	8	10	12	14	16	18	20	22	24
	1,4	6	8	10	12	14	16	18	20	22	24
	1,6	6	8	10	12	14	16	18	20	22	24
	1,8	6	8	10	12	14	16	18	20	22	24
2,8	1	6	8	10	12	14	16	18	20	22	24
	1,2	6	8	10	12	14	16	18	20	22	24
	1,4	6	8	10	12	14	16	18	20	22	24
	1,6	6	8	10	12	14	16	18	20	22	24
	1,8	6	8	10	12	14	16	18	20	22	24

Tloušťka skla [mm] **6 mm** **8 mm** **10 mm**

Vlastnosti

Volba tloušťky skla

Monolitické zasklení - 6 úchyt

Výška [m]	Šířka [m]	Tlak větru na fasádní prvek při SLS (Serviceability Limit State) [Pa]									
		400	500	600	700	800	900	1000	1100	1200	1300
3	1	6	8	10	12	14	16	18	20	22	24
	1,2	6	8	10	12	14	16	18	20	22	24
	1,4	6	8	10	12	14	16	18	20	22	24
	1,6	6	8	10	12	14	16	18	20	22	24
	1,8	6	8	10	12	14	16	18	20	22	24
3,2	1	6	8	10	12	14	16	18	20	22	24
	1,2	6	8	10	12	14	16	18	20	22	24
	1,4	6	8	10	12	14	16	18	20	22	24
	1,6	6	8	10	12	14	16	18	20	22	24
	1,8	6	8	10	12	14	16	18	20	22	24
3,4	1	6	8	10	12	14	16	18	20	22	24
	1,2	6	8	10	12	14	16	18	20	22	24
	1,4	6	8	10	12	14	16	18	20	22	24
	1,6	6	8	10	12	14	16	18	20	22	24
	1,8	6	8	10	12	14	16	18	20	22	24
3,6	1	6	8	10	12	14	16	18	20	22	24
	1,2	6	8	10	12	14	16	18	20	22	24
	1,4	6	8	10	12	14	16	18	20	22	24
	1,6	6	8	10	12	14	16	18	20	22	24
	1,8	6	8	10	12	14	16	18	20	22	24

Glass thickness [mm] **6 mm** **8 mm** **10 mm**

Tabulky výkonnosti stanovené pro zasklení s upevňovacími prvky umístěnými 100 mm od okraje zasklení. K dispozici jsou rozměry 2,80 x 3,60 m. Pro ověření vlastností výrobku a zasklení kontaktujte společnost SADEV.

PERFORMANCE

GLASS THICKNESSES CHOICE

Monolithic glazing - 8 fasteners

Height [m]	Width [m]	Wind pressure on the facade element at SLS (Serviceability Limit State) [Pa]															
		400	500	600	700	800	900	1000	1100	1200	1300	1400	1500	1600	1700	1800	
1,6	1	6	6	6	6	6	6	6	6	6	6	6	6	6	6	6	
	1,2	6	6	6	6	6	6	6	6	6	6	6	6	6	6	6	
	1,4	6	6	6	6	6	6	6	6	6	6	6	6	6	6	6	
	1,6	6	6	6	6	6	6	6	6	6	6	6	6	6	6	6	
	1,8	6	6	6	6	6	6	6	6	6	6	6	6	6	6	6	
1,8	1	6	6	6	6	6	6	6	6	6	6	6	6	6	6	6	
	1,2	6	6	6	6	6	6	6	6	6	6	6	6	6	6	6	
	1,4	6	6	6	6	6	6	6	6	6	6	6	6	6	6	6	
	1,6	6	6	6	6	6	6	6	6	6	6	6	6	6	6	6	
	1,8	6	6	6	6	6	6	6	6	6	6	6	6	6	6	6	
2	1	6	6	6	6	6	6	6	6	6	6	6	6	6	6	6	
	1,2	6	6	6	6	6	6	6	6	6	6	6	6	6	6	6	
	1,4	6	6	6	6	6	6	6	6	6	6	6	6	6	6	6	
	1,6	6	6	6	6	6	6	6	6	6	6	6	6	6	6	6	
	1,8	6	6	6	6	6	6	6	6	6	6	6	6	6	6	6	
2,2	1	6	6	6	6	6	6	6	6	6	6	6	6	6	6	6	
	1,2	6	6	6	6	6	6	6	6	6	6	6	6	6	6	6	
	1,4	6	6	6	6	6	6	6	6	6	6	6	6	6	6	6	
	1,6	6	6	6	6	6	6	6	6	6	6	6	6	6	6	6	
	1,8	6	6	6	6	6	6	6	6	6	6	6	6	6	6	6	
2,4	1	6	6	6	6	6	6	6	6	6	6	6	6	6	6	6	
	1,2	6	6	6	6	6	6	6	6	6	6	6	6	6	6	6	
	1,4	6	6	6	6	6	6	6	6	6	6	6	6	6	6	6	
	1,6	6	6	6	6	6	6	6	6	6	6	6	6	6	6	6	
	1,8	6	6	6	6	6	6	6	6	6	6	6	6	6	6	6	
2,6	1	6	6	6	6	6	6	6	6	6	6	6	6	6	6	6	
	1,2	6	6	6	6	6	6	6	6	6	6	6	6	6	6	6	
	1,4	6	6	6	6	6	6	6	6	6	6	6	6	6	6	6	
	1,6	6	6	6	6	6	6	6	6	6	6	6	6	6	6	6	
	1,8	6	6	6	6	6	6	6	6	6	6	6	6	6	6	6	

Glass thickness [mm] 6 mm 8 mm 10 mm

PERFORMANCE

GLASS THICKNESSES CHOICE

Monolithic glazing - 8 fasteners

Height [m]	Width [m]	Wind pressure on the facade element at SLS (Serviceability Limit State) [Pa]															
		400	500	600	700	800	900	1000	1100	1200	1300	1400	1500	1600	1700	1800	
2,8	1	6	6	6	6	6	6	6	6	6	6	6	6	6	6	6	
	1,2	6	6	6	6	6	6	6	6	6	6	6	6	6	6	6	
	1,4	6	6	6	6	6	6	6	6	6	6	6	6	6	6	6	
	1,6	6	6	6	6	6	6	6	6	6	6	6	6	6	6	6	
	1,8	6	6	6	6	6	6	6	6	6	6	6	6	6	6	6	
3	1	6	6	6	6	6	6	6	6	6	6	6	6	6	6	6	
	1,2	6	6	6	6	6	6	6	6	6	6	6	6	6	6	6	
	1,4	6	6	6	6	6	6	6	6	6	6	6	6	6	6	6	
	1,6	6	6	6	6	6	6	6	6	6	6	6	6	6	6	6	
	1,8	6	6	6	6	6	6	6	6	6	6	6	6	6	6	6	
3,2	1	6	6	6	6	6	6	6	6	6	6	6	6	6	6	6	
	1,2	6	6	6	6	6	6	6	6	6	6	6	6	6	6	6	
	1,4	6	6	6	6	6	6	6	6	6	6	6	6	6	6	6	
	1,6	6	6	6	6	6	6	6	6	6	6	6	6	6	6	6	
	1,8	6	6	6	6	6	6	6	6	6	6	6	6	6	6	6	
3,4	1	6	6	6	6	6	6	6	6	6	6	6	6	6	6	6	
	1,2	6	6	6	6	6	6	6	6	6	6	6	6	6	6	6	
	1,4	6	6	6	6	6	6	6	6	6	6	6	6	6	6	6	
	1,6	6	6	6	6	6	6	6	6	6	6	6	6	6	6	6	
	1,8	6	6	6	6	6	6	6	6	6	6	6	6	6	6	6	
3,6	1	6	6	6	6	6	6	6	6	6	6	6	6	6	6	6	
	1,2	6	6	6	6	6	6	6	6	6	6	6	6	6	6	6	
	1,4	6	6	6	6	6	6	6	6	6	6	6	6	6	6	6	
	1,6	6	6	6	6	6	6	6	6	6	6	6	6	6	6	6	
	1,8	6	6	6	6	6	6	6	6	6	6	6	6	6	6	6	

Glass thickness [mm] 6 mm 8 mm 10 mm

Performance tables established for glazing with fasteners located 100 mm from the edge of the glazing. 2.80 x 3.60 metre dimensions available.

Contact SADEV for verification of product and glazing performance.

PERFORMANCE

GLASS THICKNESSES CHOICE

Laminated glazing - 4 fasteners

Height [m]	Width [m]	Wind pressure on the facade element at SLS (Serviceability Limit State) [Pa]						
		400	500	600	700	800	900	1000
1	0,8							
	1							
	1,2							
	1,4							
	1,6							
	1,8							
1,2	0,8							
	1							
	1,2							
	1,4							
	1,6							
	1,8							
1,4	0,8							
	1							
	1,2							
	1,4							
	1,6							
	1,8							
1,6	0,8							
	1							
	1,2							
	1,4							
	1,6							
	1,8							
1,8	0,8							
	1							
	1,2							
	1,4							
	1,6							
	1,8							
2	0,8							
	1							
	1,2							
	1,4							
	1,6							
	1,8							
2,2	0,8							
	1							
	1,2							
	1,4							
	1,6							
	1,8							

Glass thickness [mm] 6.6 PVB 8.8 PVB

PERFORMANCE

GLASS THICKNESSES CHOICE

Laminated glazing - 4 fasteners

Height [m]	Width [m]	Wind pressure on the facade element at SLS (Serviceability Limit State) [Pa]							
		1100	1200	1300	1400	1500	1600	1700	1800
1	0,8								
	1								
	1,2								
	1,4								
	1,6								
	1,8								
1,2	0,8								
	1								
	1,2								
	1,4								
	1,6								
	1,8								
1,4	0,8								
	1								
	1,2								
	1,4								
	1,6								
	1,8								
1,6	0,8								
	1								
	1,2								
	1,4								
	1,6								
	1,8								
1,8	0,8								
	1								
	1,2								
	1,4								
	1,6								
	1,8								
2	0,8								
	1								
	1,2								
	1,4								
	1,6								
	1,8								

Glass thickness [mm] 6.6 PVB 8.8 PVB

Performance tables established for glazing with fasteners located 100 mm from the edge of the glazing. 2.80 x 3.60 metre dimensions available.

Contact SADEV for verification of product and glazing performance.

PERFORMANCE

GLASS THICKNESSES CHOICE

Laminated glazing - 6 fasteners

Height [m]	Width [m]	Wind pressure on the facade element at SLS (Serviceability Limit State) [Pa]															
		400	500	600	700	800	900	1000	1100	1200	1300	1400	1500	1600	1700	1800	
1,6	1																
	1,2																
	1,4																
	1,6																
	1,8																
1,8	1																
	1,2																
	1,4																
	1,6																
	1,8																
2	1																
	1,2																
	1,4																
	1,6																
	1,8																
2,2	1																
	1,2																
	1,4																
	1,6																
	1,8																
2,4	1																
	1,2																
	1,4																
	1,6																
	1,8																
2,6	1																
	1,2																
	1,4																
	1,6																
	1,8																

Glass thickness [mm] 6.6 PVB 8.8 PVB

PERFORMANCE

GLASS THICKNESSES CHOICE

Laminated glazing - 6 fasteners

Height [m]	Width [m]	Wind pressure on the facade element at SLS (Serviceability Limit State) [Pa]															
		400	500	600	700	800	900	1000	1100	1200	1300	1400	1500	1600	1700	1800	
2,8	1																
	1,2																
	1,4																
	1,6																
	1,8																
3	1																
	1,2																
	1,4																
	1,6																
	1,8																
3,2	1																
	1,2																
	1,4																
	1,6																
	1,8																
3,4	1																
	1,2																
	1,4																
	1,6																
	1,8																
3,6	1																
	1,2																
	1,4																
	1,6																
	1,8																

Glass thickness [mm] 6.6 PVB 8.8 PVB

Performance tables established for glazing with fasteners located 100 mm from the edge of the glazing. 2.80 x 3.60 metre dimensions available.

Contact SADEV for verification of product and glazing performance.

PERFORMANCE

GLASS THICKNESSES CHOICE

Laminated glazing - 8 fasteners

Height [m]	Width [m]	Wind pressure on the facade element at SLS (Serviceability Limit State) [Pa]															
		400	500	600	700	800	900	1000	1100	1200	1300	1400	1500	1600	1700	1800	
1,6	1																
	1,2																
	1,4																
	1,6																
	1,8																
1,8	1																
	1,2																
	1,4																
	1,6																
	1,8																
2	1																
	1,2																
	1,4																
	1,6																
	1,8																
2,2	1																
	1,2																
	1,4																
	1,6																
	1,8																
2,4	1																
	1,2																
	1,4																
	1,6																
	1,8																
2,6	1																
	1,2																
	1,4																
	1,6																
	1,8																

Glass thickness [mm] **6.6 PVB** **8.8 PVB**

PERFORMANCE

GLASS THICKNESSES CHOICE

Laminated glazing - 8 fasteners

Height [m]	Width [m]	Wind pressure on the facade element at SLS (Serviceability Limit State) [Pa]															
		400	500	600	700	800	900	1000	1100	1200	1300	1400	1500	1600	1700	1800	
2,8	1																
	1,2																
	1,4																
	1,6																
	1,8																
3	1																
	1,2																
	1,4																
	1,6																
	1,8																
3,2	1																
	1,2																
	1,4																
	1,6																
	1,8																
3,4	1																
	1,2																
	1,4																
	1,6																
	1,8																
3,6	1																
	1,2																
	1,4																
	1,6																
	1,8																

Glass thickness [mm] **6.6 PVB** **8.8 PVB**

Performance tables established for glazing with fasteners located 100 mm from the edge of the glazing. 2.80 x 3.60 metre dimensions available.

Contact SADEV for verification of product and glazing performance.

Vlastnosti

Maximální zatížení tlaku větru na fasádu

Monolithic glazing - 4 fasteners

Wind pressure on the facade element at SLS (Serviceability Limit State) [Pa]

6 mm		Width [m]					
		0,8	1	1,2	1,4	1,6	1,8
Height [m]	1	1716	1520	856	529	346	237
	1,2	939	856	778	488	326	227
	1,4	563	529	488	450	303	215
	1,6	357	346	326	303	284	202
	1,8	240	237	227	215	202	190
	2	169	168	164	157	149	141
	2,2	123	123	122	117	113	107

Wind pressure on the facade element at SLS (Serviceability Limit State) [Pa]

8 mm		Width [m]					
		0,8	1	1,2	1,4	1,6	1,8
Height [m]	1	3119	2772	1950	1254	821	563
	1,2	2115	1950	1774	1156	773	538
	1,4	1334	1254	1156	1068	719	509
	1,6	846	821	773	719	672	478
	1,8	569	563	538	509	478	450
	2	400	397	389	372	352	333
	2,2	293	291	288	278	267	254

Wind pressure on the facade element at SLS (Serviceability Limit State) [Pa]

10 mm		Width [m]					
		0,8	1	1,2	1,4	1,6	1,8
Height [m]	1	4873	4331	3048	2241	1603	1099
	1,2	3304	3048	2772	2083	1511	1051
	1,4	2374	2241	2083	1925	1405	993
	1,6	1651	1603	1511	1405	1313	933
	1,8	1111	1099	1051	993	933	880
	2	782	776	759	726	688	651
	2,2	571	568	563	543	522	496

Vlastnosti

Maximální zatížení tlaku větru na fasádu

Monolithic glazing - 6 fasteners

Wind pressure on the facade element at SLS (Serviceability Limit State) [Pa]

6 mm		Width [m]					Width [m]					
		1	1,2	1,4	1,6	1,8	1	1,2	1,4	1,6	1,8	
Height [m]	1,6	598	491	405	353	305	2,8	275	234	204	180	164
	1,8	502	426	362	305	236	3	251	213	186	164	150
	2	437	368	315	272	235	3,2	229	196	170	152	136
	2,2	382	321	285	244	211	3,4	210	180	158	140	126
	2,4	341	288	249	221	196	3,6	194	166	146	130	117
	2,6	306	258	223	201	177						

Wind pressure on the facade element at SLS (Serviceability Limit State) [Pa]

8 mm		Width [m]					Width [m]					
		1	1,2	1,4	1,6	1,8	1	1,2	1,4	1,6	1,8	
Height [m]	1,6	598	491	405	353	305	2,8	275	234	204	180	164
	1,8	502	426	362	305	236	3	251	213	186	164	150
	2	437	368	315	272	235	3,2	229	196	170	152	136
	2,2	382	321	285	244	211	3,4	210	180	158	140	126
	2,4	341	288	249	221	196	3,6	194	166	146	130	117
	2,6	306	258	223	201	177						

Wind pressure on the facade element at SLS (Serviceability Limit State) [Pa]

10 mm		Width [m]					Width [m]					
		1	1,2	1,4	1,6	1,8	1	1,2	1,4	1,6	1,8	
Height [m]	1,6	1587	1303	1076	940	809	2,8	730	620	540	478	436
	1,8	1333	1131	960	809	720	3	665	566	493	435	397
	2	1161	976	837	721	631	3,2	609	519	451	402	362
	2,2	1014	853	756	648	559	3,4	558	477	418	372	333
	2,4	905	764	661	586	520	3,6	514	441	387	344	311
	2,6	811	685	592	534	471						

PERFORMANCE

CHECKING MAXIMUM PERMISSIBLE WIND PRESSURES

Monolithic glazing - 8 fasteners

Wind pressure on the facade element at SLS (Serviceability Limit State) [Pa]

		Width [m]					Width [m]						
		1	1,2	1,4	1,6	1,8	1	1,2	1,4	1,6	1,8		
Height [m]	6 mm	1,6	912	750	559	353	352	2,8	458	388	329	278	235
	1,8	814	646	550	352	236	3	418	351	303	266	228	
	2	709	565	482	352	236	3,2	382	321	285	244	211	
	2,2	641	521	428	353	236	3,4	354	299	260	227	203	
	2,4	561	465	385	336	236	3,6	328	277	240	215	189	
	2,6	502	426	362	305	236							

Wind pressure on the facade element at SLS (Serviceability Limit State) [Pa]

		Width [m]					Width [m]						
		1	1,2	1,4	1,6	1,8	1	1,2	1,4	1,6	1,8		
Height [m]	8 mm	1,6	1529	1257	1067	836	802	2,8	768	651	551	467	416
	1,8	1364	1083	922	802	560	3	701	588	508	445	382	
	2	1189	948	808	705	559	3,2	640	539	477	410	353	
	2,2	1074	873	718	627	557	3,4	594	501	436	381	341	
	2,4	939	780	645	564	501	3,6	551	465	403	361	317	
	2,6	842	714	606	511	455							

Wind pressure on the facade element at SLS (Serviceability Limit State) [Pa]

		Width [m]					Width [m]						
		1	1,2	1,4	1,6	1,8	1	1,2	1,4	1,6	1,8		
Height [m]	10 mm	1,6	2420	1991	1690	1468	1270	2,8	1216	1030	872	739	658
	1,8	2159	1714	1459	1270	1094	3	1110	931	805	705	605	
	2	1882	1501	1279	1116	989	3,2	1014	853	756	648	559	
	2,2	1700	1382	1137	993	881	3,4	940	793	690	604	540	
	2,4	1487	1235	1021	892	793	3,6	872	736	637	571	502	
	2,6	1333	1131	960	809	720							

PERFORMANCE

CHECKING MAXIMUM PERMISSIBLE WIND PRESSURES

Laminated glazing - 4 fasteners

Wind pressure on the facade element at SLS (Serviceability Limit State) [Pa]

		Width [m]						
		0,8	1	1,2	1,4	1,6	1,8	
Height [m]	6.6 PVB	1	4125	3666	2580	1897	1248	856
	1,2	2797	2580	2346	1758	1176	818	
	1,4	2009	1897	1758	1624	1094	773	
	1,6	1286	1248	1176	1094	1023	726	
	1,8	865	856	818	773	726	685	
	2	609	604	591	565	535	507	
	2,2	445	442	438	423	407	386	

Wind pressure on the facade element at SLS (Serviceability Limit State) [Pa]

		Width [m]						
		0,8	1	1,2	1,4	1,6	1,8	
Height [m]	8.8 PVB	1	5563	4451	3709	3179	2559	2007
	1,2	4636	3709	3091	2649	2318	1923	
	1,4	3569	3179	2649	2271	1987	1766	
	1,6	2644	2559	2318	1987	1739	1545	
	1,8	2035	2007	1923	1766	1545	1374	
	2	1441	1430	1399	1337	1267	1199	
	2,2	1053	1047	1037	1002	962	913	

Monolithic glazing - 6 fasteners

Wind pressure on the facade element at SLS (Serviceability Limit State) [Pa]

6.6 PVB		Width [m]				
		1	1,2	1,4	1,6	1,8
Height [m]	1,6	1406	1155	953	833	717
	1,8	1181	1002	850	717	638
	2	1028	864	741	638	559
	2,2	898	756	669	574	495
	2,4	802	677	586	520	461
	2,6	719	607	525	473	417
	2,8	647	550	479	424	386
	3	589	502	437	386	352
	3,2	539	460	399	356	321
	3,4	494	423	370	329	295
	3,6	455	390	343	305	276

Wind pressure on the facade element at SLS (Serviceability Limit State) [Pa]

8.8 PVB		Width [m]				
		1	1,2	1,4	1,6	1,8
Height [m]	1,6	2355	1933	1596	1394	1200
	1,8	1977	1678	1424	1200	1068
	2	1722	1447	1241	1069	935
	2,2	1504	1265	1121	962	829
	2,4	1343	1133	981	870	772
	2,6	1204	1016	879	792	698
	2,8	1083	920	801	709	646
	3	986	840	732	646	589
	3,2	903	770	668	597	537
	3,4	828	708	620	552	494
	3,6	762	654	575	510	461

Laminated glazing - 8 fasteners

Wind pressure on the facade element at SLS (Serviceability Limit State) [Pa]

6.6 PVB		Width [m]				
		1	1,2	1,4	1,6	1,8
Height [m]	1,6	2144	1764	1497	1271	1125
	1,8	1913	1519	1293	1125	852
	2	1668	1330	1134	989	850
	2,2	1506	1224	1007	879	781
	2,4	1318	1094	904	791	703
	2,6	1181	1002	850	717	638
	2,8	1077	912	773	654	583
	3	983	825	713	625	536
	3,2	898	756	669	574	495
	3,4	833	702	611	535	478
	3,6	772	652	565	506	444

Wind pressure on the facade element at SLS (Serviceability Limit State) [Pa]

8.8 PVB		Width [m]				
		1	1,2	1,4	1,6	1,8
Height [m]	1,6	3590	2953	2507	2178	1884
	1,8	3203	2543	2165	1884	1667
	2	2792	2226	1898	1655	1467
	2,2	2522	2050	1686	1472	1307
	2,4	2206	1832	1514	1324	1177
	2,6	1977	1678	1424	1200	1068
	2,8	1803	1528	1294	1096	976
	3	1646	1382	1194	1046	898
	3,2	1504	1265	1121	962	829
	3,4	1395	1176	1023	895	801
	3,6	1293	1092	945	847	744